



AL

TRITURADORA AL

CARACTERÍSTICAS	T-AL-URL-5-1600	T-AL-URL-5-1800	T-AL-URL-5-2000	T-AL-URL-5-2300	T-AL-URL-5-2600	T-AL-URL-5-2800	T-AL-URL-5-3000	T-AL-URL-5-3200
Ancho Trabajo Working width / Largeur de travail Arbeitsbreite	1600	1800	2000	2300	2600	2800	3000	3200
Ancho total Total width / Largeur totale Gesamtbreite	1780	1980	2180	2480	2780	2980	3180	3380
Peso Kg. Weight kg / Poids (kg.) Gewicht Kg.	695	725	755	805	850	885	915	950
Martillos Hammers / Marteaux Hammer	16	16	20	24	24	26	30	30
Correas V-belts / Courroies Gürtel	3	3	3	4	4	4	4	4
HP (indicativo) HP (indicative) / Ch (indicatif) PS (Richtwert)	50-10	60-80	70-90	70-100	80-100	90-120	110-140	120-160
R.P.M. R.P.M. / tr/min U/min	540-1000	540-1000	540-1000	540-1000	540-1000	540-1000	1000	1000
EJE SHAFT / AXE ACHSE	1 3/8 Z-6	1 3/8 Z-6	1 3/8 Z-6	1 3/8 Z-6	1 3/8 Z-6	1 3/8 Z-6	1 3/8 Z-6	1 3/8 Z-6



TRITURADORAS PICURSA, S.L.
Ctra. Gallur-Sangüesa, km. 16,700
50660 Tauste (Zaragoza) España
Tel.: +34 976 85 43 28
trituradoras@picursa.com

DELEGACIÓN SUR PICURSA
Polígono Cornicabral, Nave 11
23280 Beas de Segura (Jaén)

[youtube.com/TrituradorasPicursa](https://www.youtube.com/TrituradorasPicursa)



Distribuidor / Reseller / Revendeur / Verteiler



AL



AGRICULTURAL MULCHERS
BROYEUR AGRICOLE
LANDWIRTSCHAFTLICHE MULCHER

TRITURADORAS AGRICOLAS

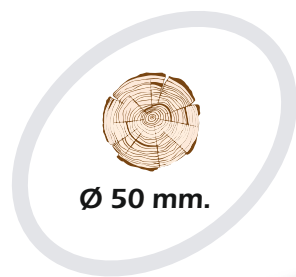

Ø 50 mm.

- ROTOR MARTILLO OSCILANTE CON DISTRIBUCIÓN ESPECIAL, BAJA ABSORCIÓN DE POTENCIA
- SWINGING HAMMER ROTOR WITH SPECIAL DISTRIBUTION, LOW POWER ABSORPTION
- ROTOR MARTEAUX OSCILLANTS AVEC DISTRIBUCION SPÉCIALE, FAIBLE ABSORTION DE PUISSANCE
- OSZILLIERENDER HAMMERROTOR MIT SPEZIELLER VERTEILUNG, NIEDRIGER ENERGIEVERBRAUCH

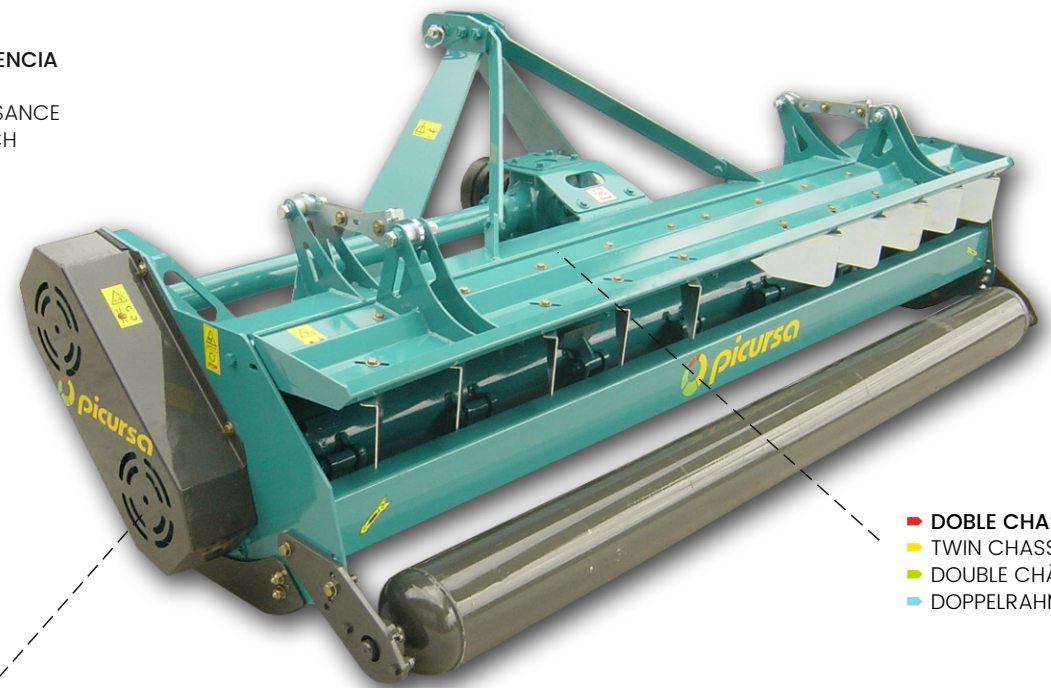
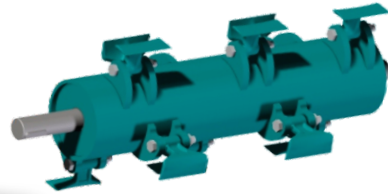
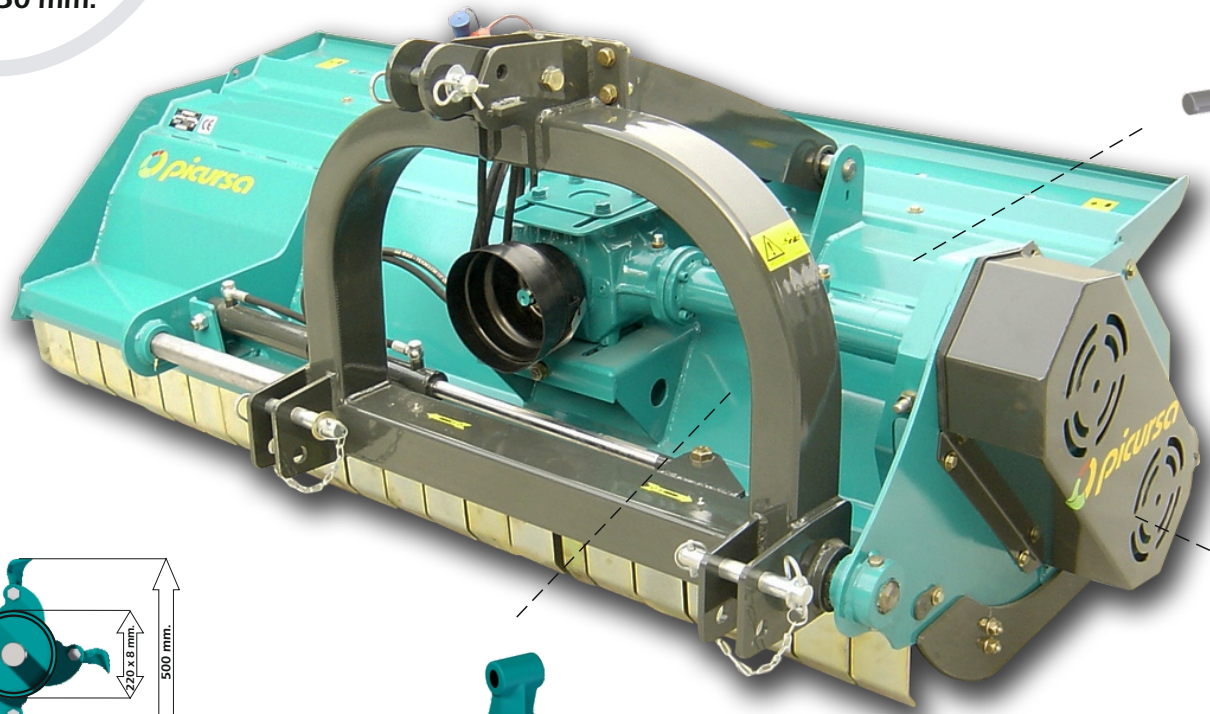

- DOBLE CHASIS
- TWIN CHASSIS
- DOUBLE CHÂSSIS
- DOPPELRAHMEN

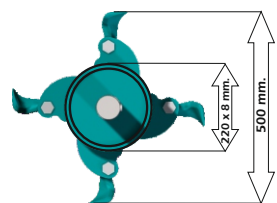

- DIAMETRO EJE Ø 50 mm.
- AXLE DIAMETER Ø 50 mm.
- DIAMÈTRE DE L'AXE Ø 50 mm.
- ACHSDURCHMESSER Ø 50 mm.

- TIPO MARTILLO
- HAMMER TYPES
- TYPE DE MARTEAU
- HAMMERTYP



- CARCASAS DE RODAMIENTOS EN HIERRO FUNDIDO
- CAST IRON BEARING SHELLS
- STRUCTURES DE ROULEMENT EN FONTE
- LAGERGEHÄUSE AUS GUSSEISEN

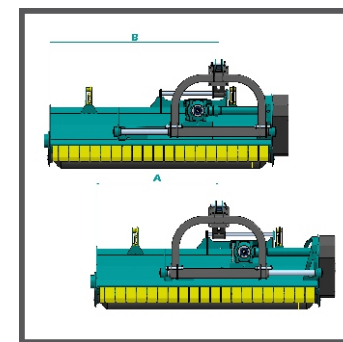

Ancho Trabajo Working width / Largeur de travail Arbeitsbreite	A mm.	B mm.
1600	580	1050
1800	780	1250
2000	980	1450
2300	1280	1750
2400	1480	1950
2600	1480	1950
2800	1580	2050
3000	1680	2150
3200	1780	2250

ACCESORIOS OPCIONALES - OPTIONAL ACCESSORIES - ACCESSOIRES OPTIONNELS - OPTIONALES ZUBEHÖR



- RASCADOR DEL RULO TRASERO
- REAR ROLLER SCRAPER
- RACLETTE DU ROULEAU ARRIÈRE
- ABSTREIFER FÜR HINTERE WALZE



- JUEGO DE CADENAS DELANTERAS
- FRONT CHAIN SET
- ENSEMBLE CHÂÎNES AVANT
- KETTENSATZ VORNE



- JUEGO GUARDAPOLVOS PARA ALAMBRE
- DUST-GUARD SET FOR WIRES
- ENSEMBLE DE PROTECTION ANTI-FIL DE FER
- SATZ STAUBMÄNTEL FÜR DRÄHTE

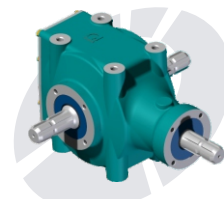

- PLUS GRUPO CON RUEDA LIBRE
- PLUS GROUP WITH FREE WHEEL
- PLUS GROUPE AVEC ROUE LIBRE
- PLUS FREIE RADGRUPPE



- PLUS TRANSMISIÓN CON RUEDA LIBRE
- FREE WHEEL TRANSMISSION
- TRANSMISSION À ROUE LIBRE
- GETRIEBE MIT FREIEM RAD

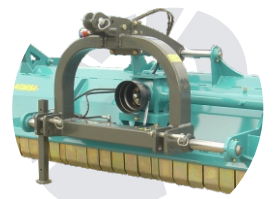

- DESPLAZAMIENTO HIDRÁULICO
- HYDRAULIC MOVEMENT
- DÉPLACEMENT HYDRAULIQUE
- HYDRAULISCHE BEFÖRDERUNG

ES

La trituradora de tractor AL es un modelo económico ideal para la trituración de residuos de los cultivos, hierba, matorrales bajos. Baja absorción de potencia. Rulo o ruedas para la regulación de altura. Compuerta abatible hidráulica o manual. Construcción sólida y robusta. Triturado uniforme.

- DOBLE CHASIS
- CORREAS CON FIBRA DE KEVLAR
- SISTEMA FLOTANTE DE TRABAJO
- MARTILLOS BAJA ABSORCIÓN DE POTENCIA
- TORNILLOS DE LOS MARTILLOS EN ACERO 10.9
- ALETAS REGULABLES
- TRANSMISIÓN INCLUIDA

EN

The AL mulcher for tractor is an economical model that is ideal for shredding waste from crops, grass and low scrub. Low power absorption. Roller or wheels for height adjustment. Hydraulic or manually controlled hinged hood. Solid and sturdily built. Uniform shredding.

- TWIN CHASSIS
- V-BELT WITH KEVLAR FIBRE.
- FLOATING WORK SYSTEM
- HAMMERS WITH LOW POWER ABSORPTION
- HAMMER SCREWS MADE OF 10.9 STEEL.
- ADJUSTABLE BLADES.
- TRANSMISSION INCLUDED.

FR

Très économique, le broyeur pour tracteur AL est parfait pour le broyage de résidus de cultures, d'herbe et de fourrés bas. Faible absorption de puissance. Rouleau ou roues pour réglage de hauteur. Porte rabattable hydraulique ou manuelle. Construction robuste et durable. Broyage uniforme.

- DOUBLE CHÂSSIS
- COURROIES EN FIBRE DE KEVLAR
- SYSTÈME FLOTTANT DE TRAVAIL
- MARTEAUX FAIBLE ABSORPTION DE PUISSANCE
- VIS DES MARTEAUX EN ACIER 10.9
- ABATTANTS DIRECTIONNELS
- TRANSMISSION INCLUSE.

DE

Der landwirtschaftliche Mulcher Modell AL, ist eine kostengünstige Lösung für die Zerkleinerung von Pflanzen-, Gras- und Gestrüppresten. Niedrige Leistungsaufnahme. Walze oder Räder zur Höheneinstellung. Hydraulisch oder manuell herunterklappbare Klappe. Sehr stabile und widerstandsfähige Bauweise. Gleichförmige Zerkleinerung.

- DOPPELRAHMEN
- KEILRIEMEN AUS KEVLAR-FASER
- SCHWEBENDES ARBEITSSYSTEM
- HÄMMER MIT NIEDRIGER LEISTUNGS-AUFNAHME
- HAMMERSCHRAUBEN AUS STAHL 10.9
- VERSTELLBARE BLENDEN
- EINSCHLIESSLICH GETRIEBE